

**Diethard Thieme**  
**Skripte zur Baumechanik**

**Übungen**  
**mit**  
**Lösungen**  
**BM 43**

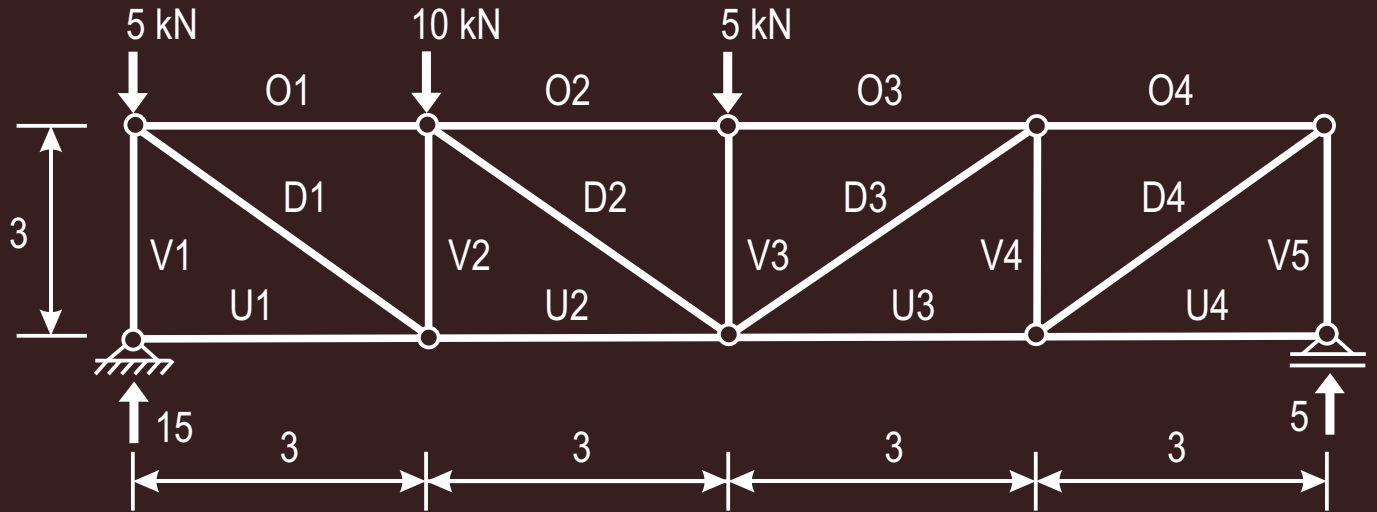

Stab	1	2	3	4	5
O	-10	-10	-10	-5	
U	0	10	5	0	
V	-15	-10	-5	-5	-5
D	14,1	0	7,07	7,07	

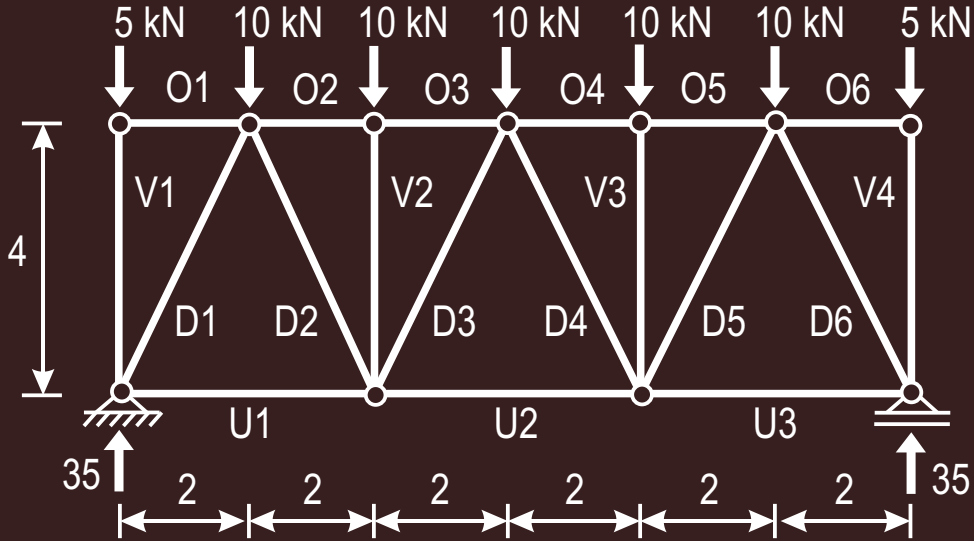

Stab	1	2	3	4	5	6
O	0	- 25	- 25	- 25	- 25	0
U	15	30	15			
V	- 5	- 10	- 10	- 5		
D	- 33,6	22,4	- 11,2	- 11,2	22,4	- 33,6

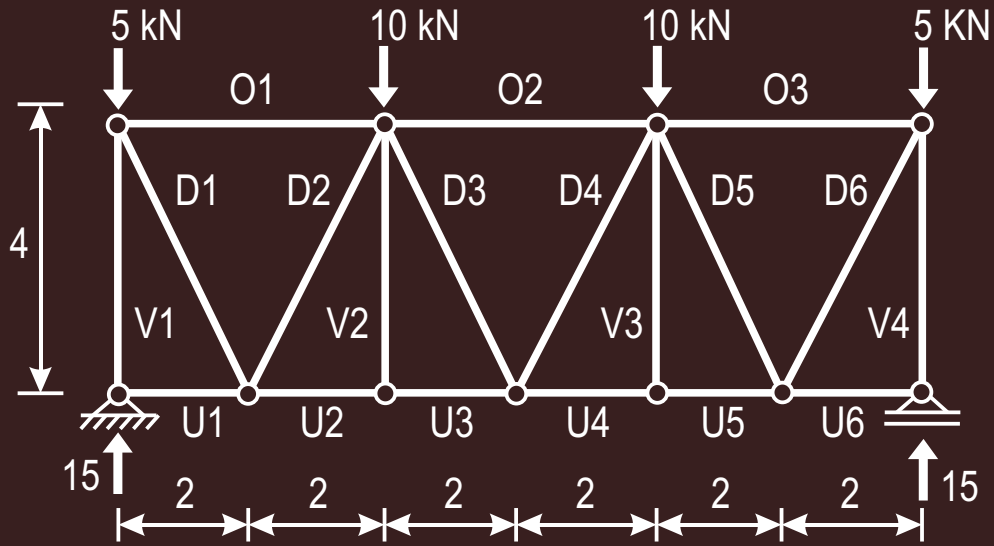

Stab	1	2	3	4	5	6
O	- 5	- 10	- 5			
U	0	10	10	10	10	0
V	- 15	0	0	- 15		
D	11,2	- 11,2	0	0	- 11,2	11,2

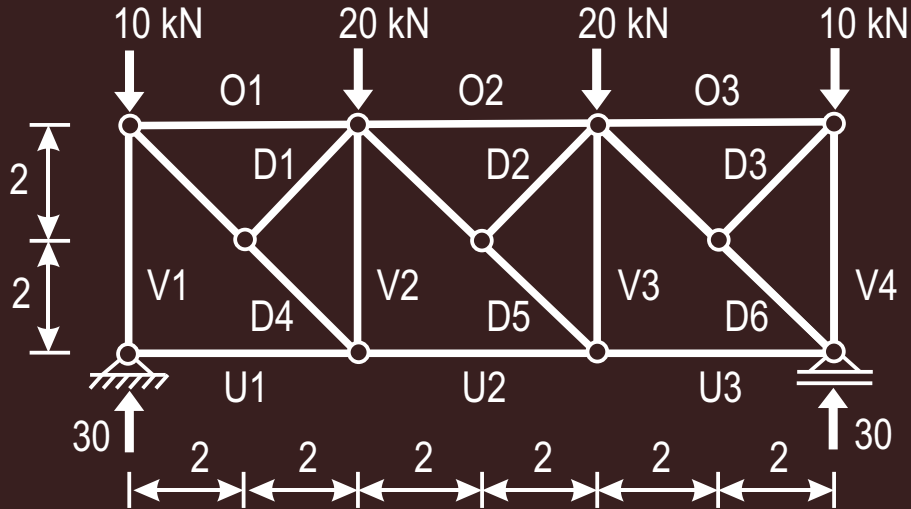

Stab	1	2	3	4	5	6
O	-20	-20	0			
U	0	20	20			
V	-30	-20	0	-10		
D	0	0	0	28,3	0	-28,3

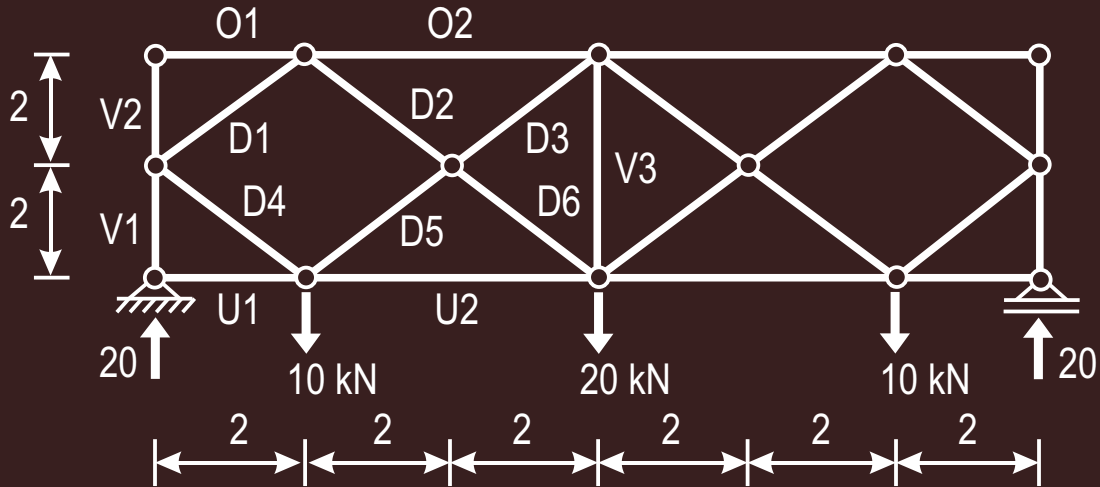

Stab	1	2	3	4	5	6
O	0	-20				
U	0	10				
V	0	-20	0			
D	-14,1	14,1	0	14,1	0	14,1

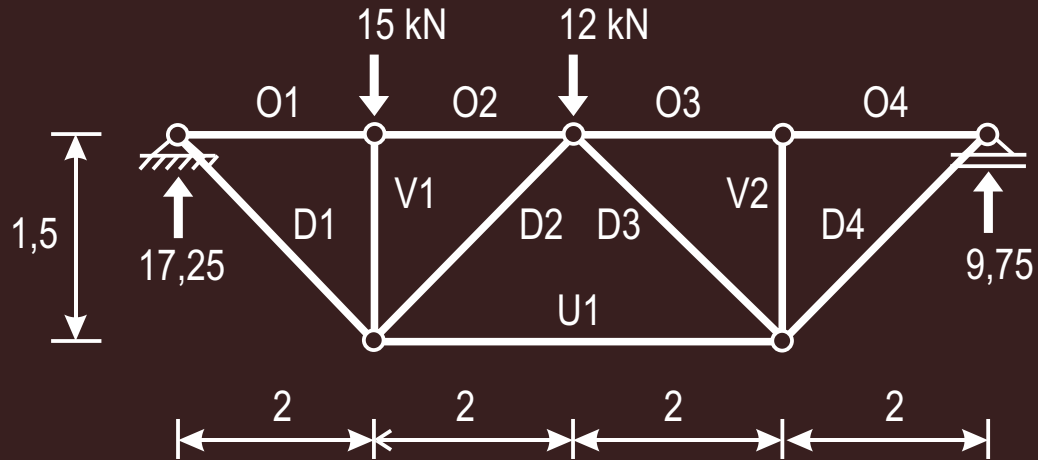

Stab	1	2	3	4
O	- 23	- 23	- 13	- 13
U	26			
V	- 15	0		
D	28,75	- 3,75	- 16,25	16,25

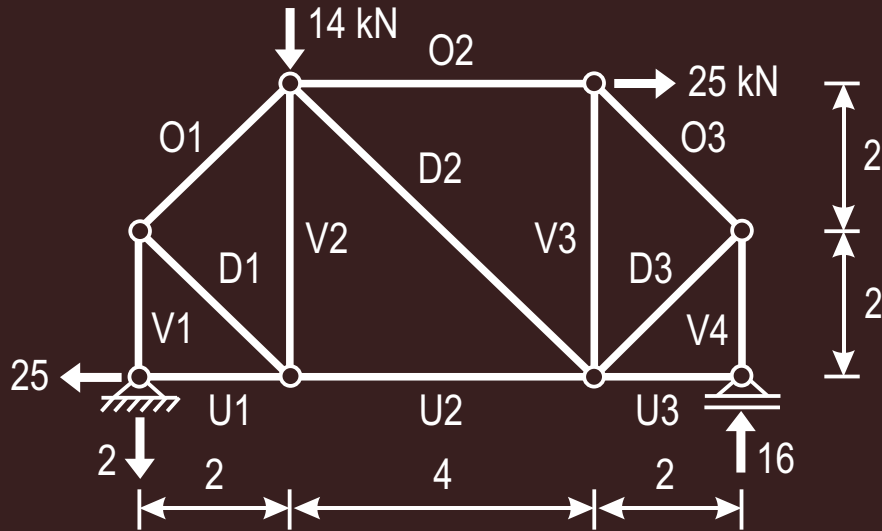

Stab	1	2	3	4
O	1,41	17	- 11,3	
U	25	24	0	
V	2	1	8	- 16
D	- 1,41	- 22,6	11,3	



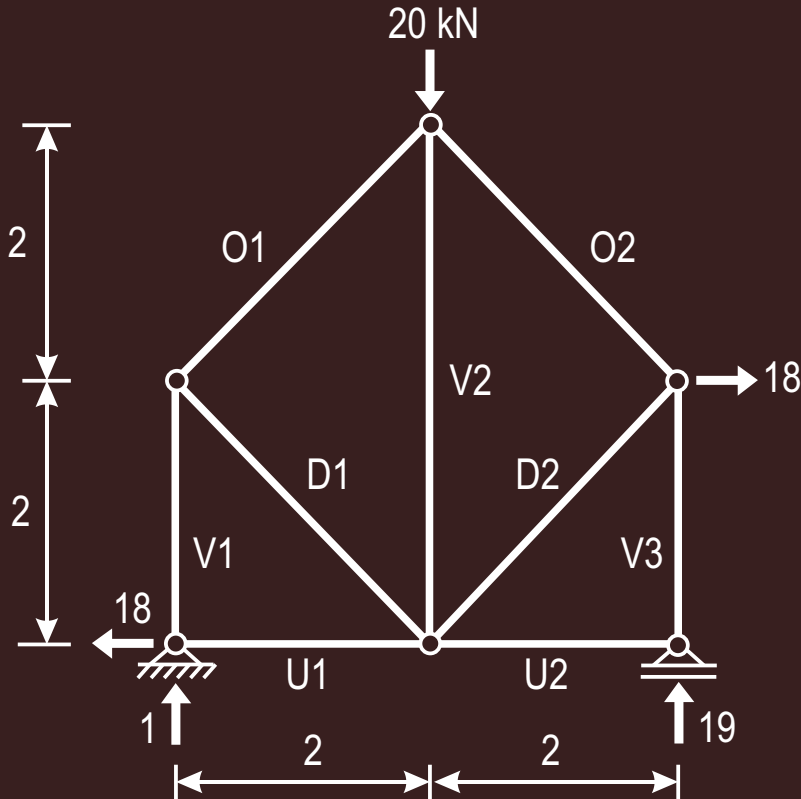

Stab	1	2	3
O	-0,71	-0,71	
U	18	0	
V	-1	-19	-19
D	0,71	26,2	0

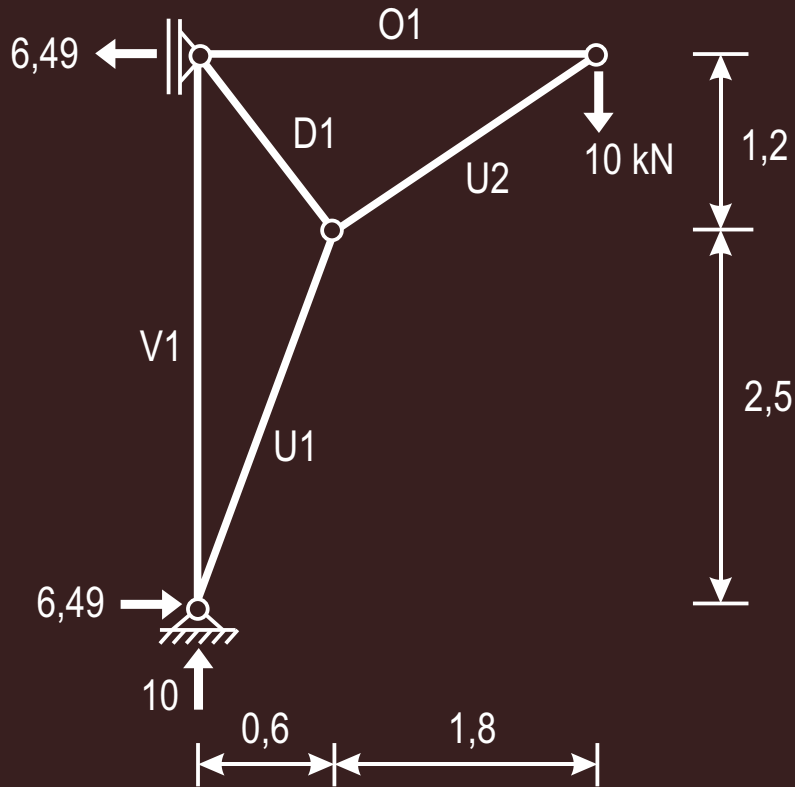

Stab	1	2
O	15	
U	- 27,9	- 18
V	17,1	
D	- 19	

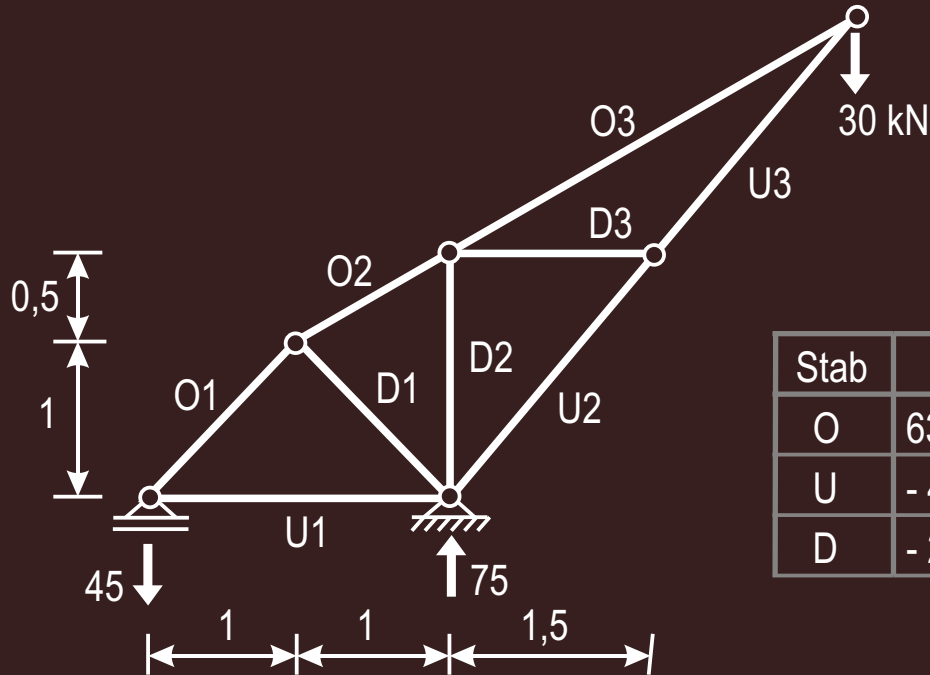

Stab	1	2	3
O	63,6	67,1	67,1
U	-45	-84,9	-84,9
D	-21,2	0	0

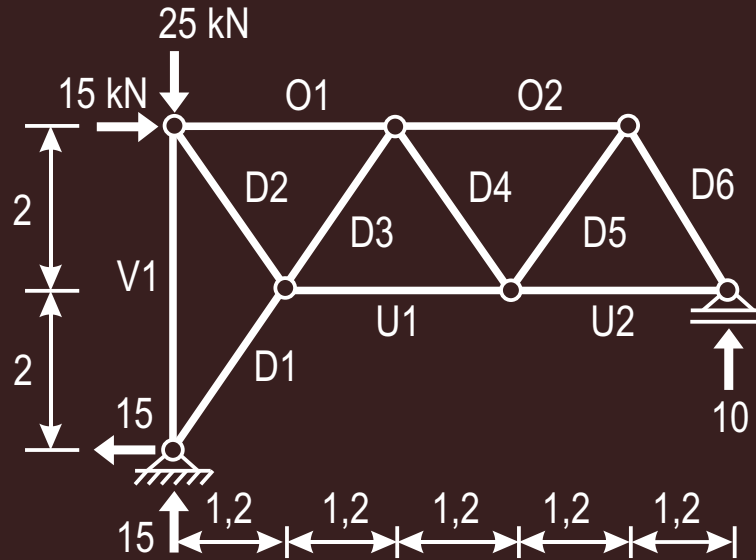

Stab	1	2	3	4	5	6
O	- 24	- 12				
U	18	6				
V	- 40					
D	29,1	17,5	11,7	- 11,7	11,7	- 11,7

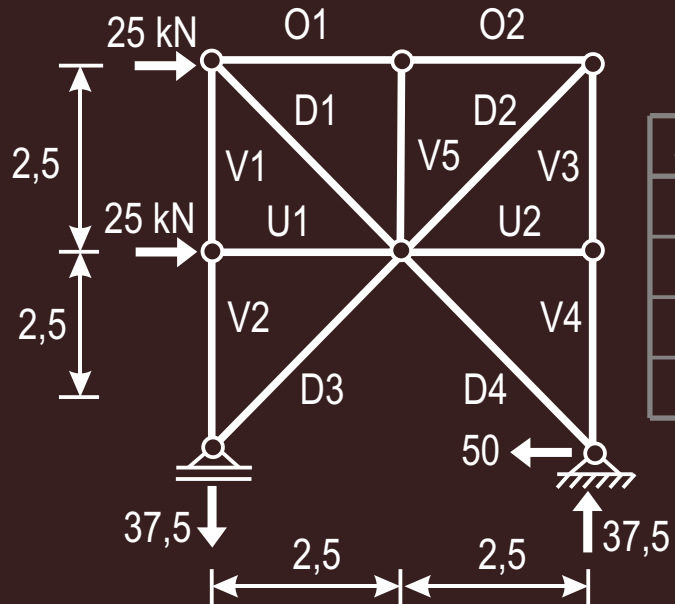

Stab	1	2	3	4	5
O	12,5	12,5			
U	- 25	0			
V	37,5	37,5	12,5	12,5	0
D	- 53	- 17,7	0	- 70,7	

"Balken" mit einem festen Gelenklager und einem Pendelstab (D4)

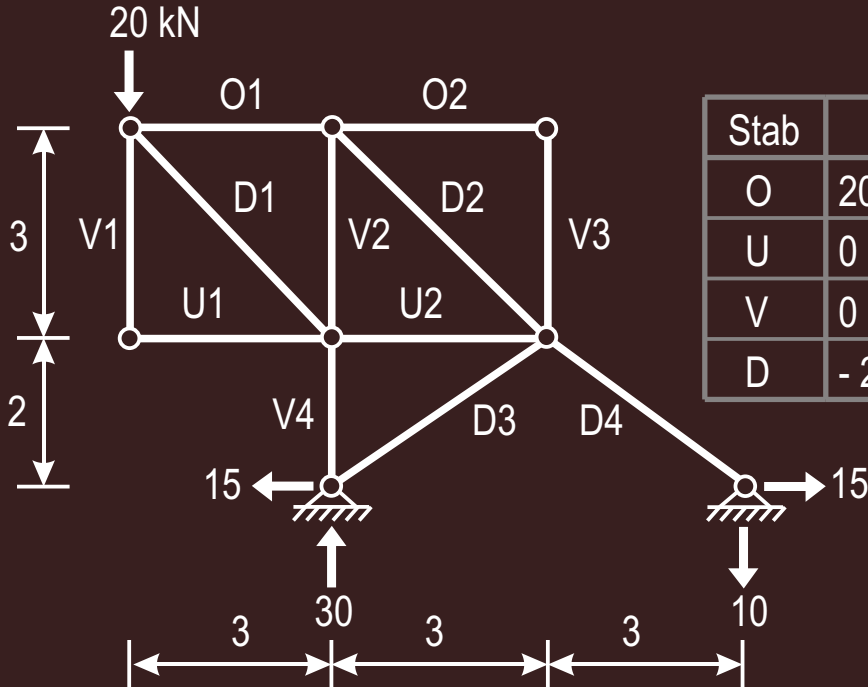

Stab	1	2	3	4
O	20	0		
U	0	-20		
V	0	-20	0	-40
D	-28,3	28,3	18	18

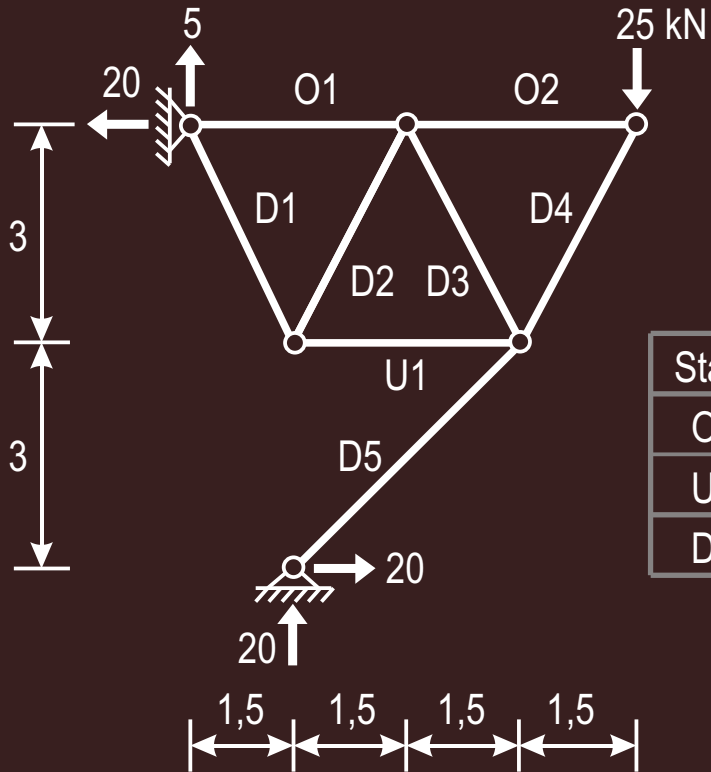

Stab	1	2	3	4	5
O	17,5	12,5			
U	5				
D	5,59	- 5,59	5,59	- 27,9	- 28,3

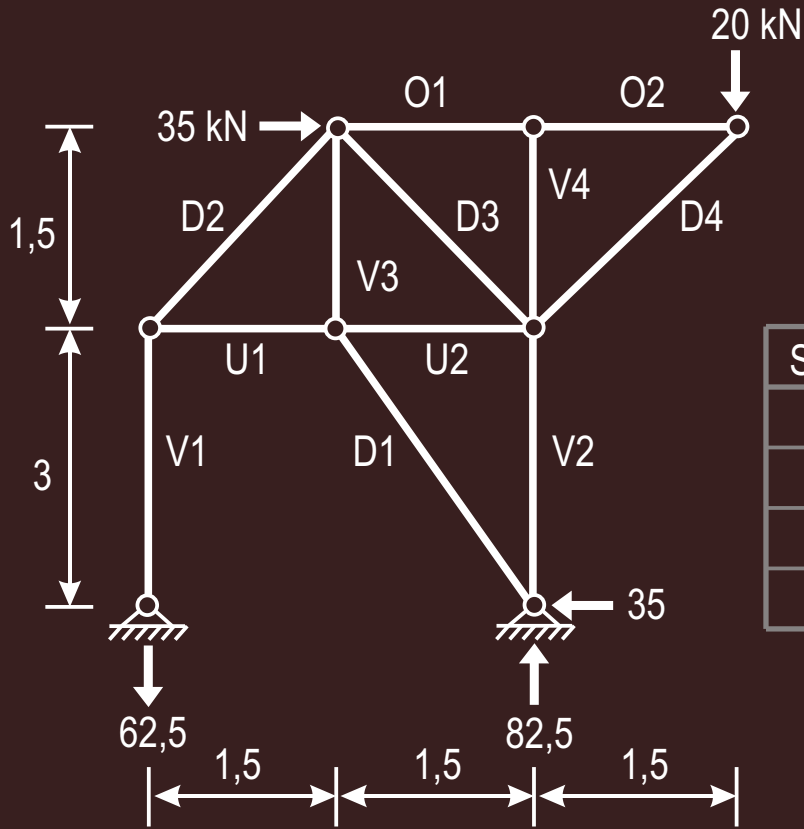

Stab	1	2	3	4
O	20	20		
U	- 62,5	- 27,5		
V	62,5	- 12,5	- 70	0
D	- 78,3	88,4	10,5	- 28,3



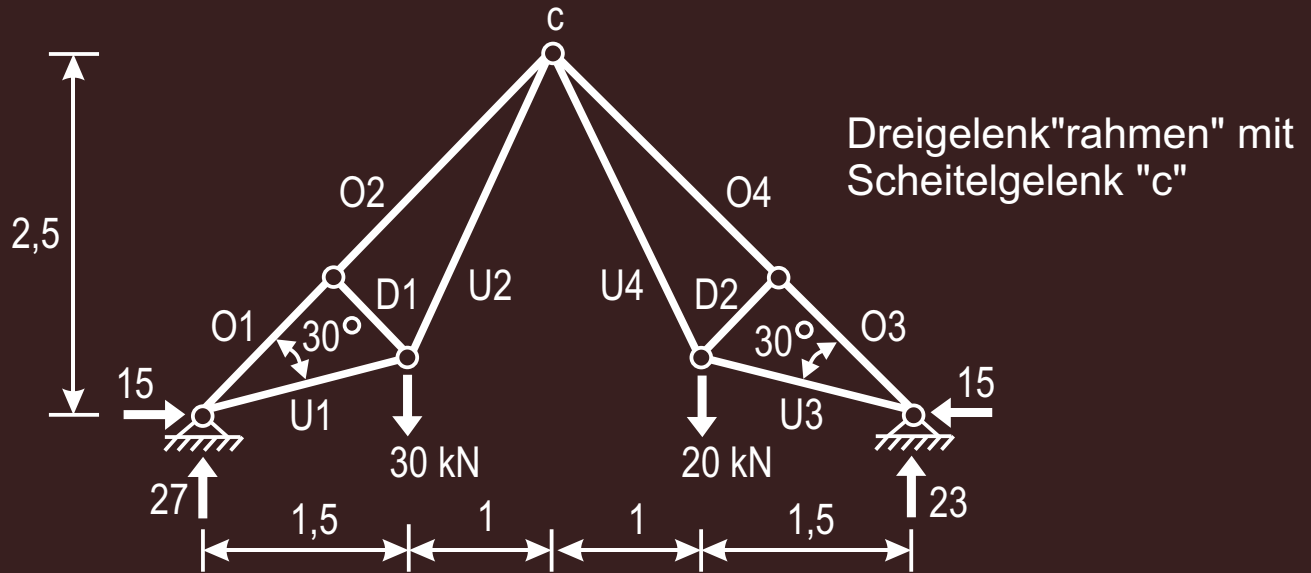

Stab	1	2	3	4
O	-44,4	-44,4	-36,7	-36,7
U	17	38,1	11,4	25,4
D	0	0		

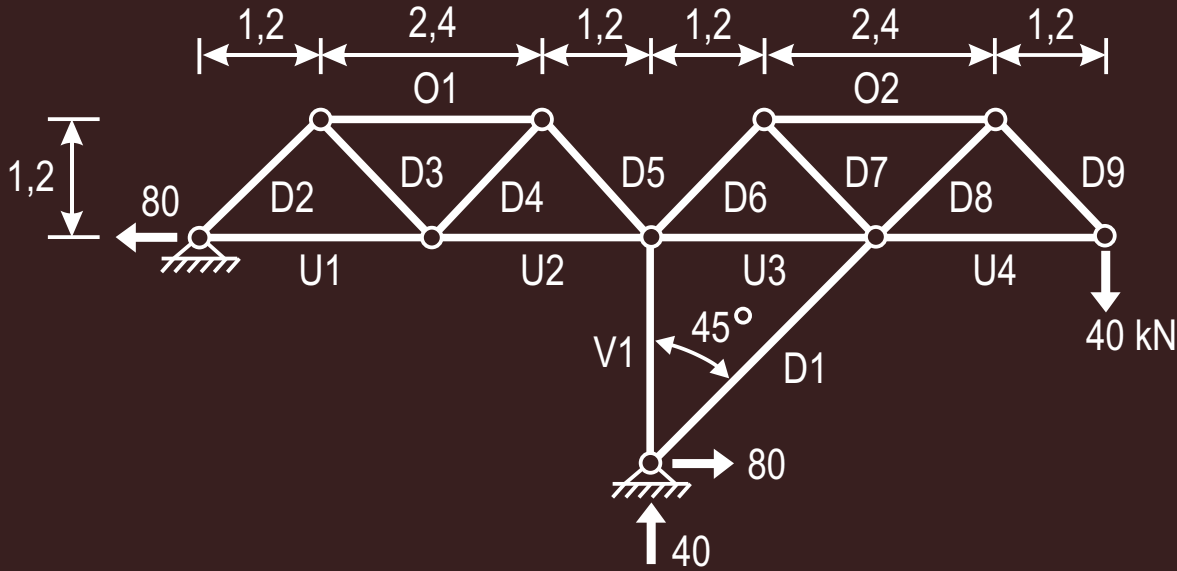

Stab	1	2	3	4	5	6	7	8	9
O	0	80							
U	80	80	40	-40					
V	40								
D	-113,1	0	0	0	0	56,6	-56,6	-56,6	56,6

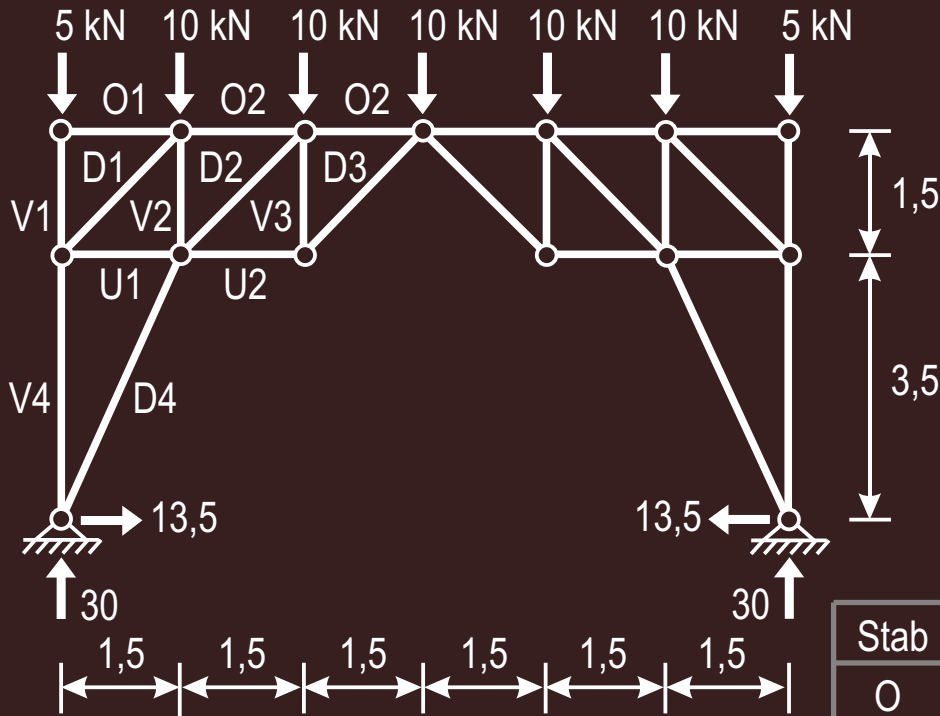

Stab	1	2	3	4
O	0	6,5	-8,5	
U	-6,5	-5		
V	-5	-16,5	5	1,5
D	9,19	-21,2	-7,07	-34,3

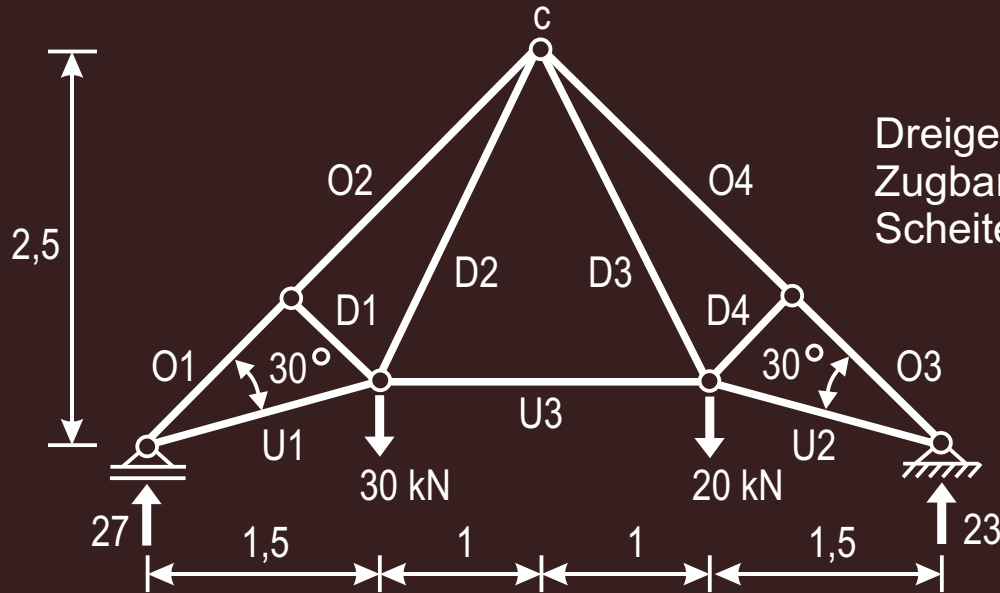

Stab	1	2	3	4
O	- 52,2	- 52,2	- 44,5	- 44,5
U	40,9	34,8	17,9	
D	0	44,2	31,5	0

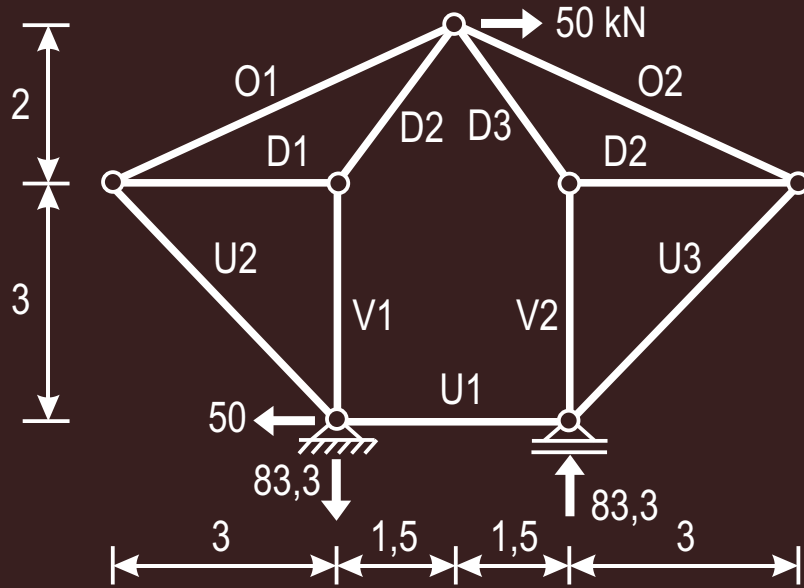

Stab	1	2	3	4
O	-61,7	61,7		
U	25	-35,4	35,4	
V	108,3	-108,3		
D	81,4	135,4	-135,4	-81,4

## Gelenkträger aus zwei Fachwerkscheiben über zwei Felder mit Feldgelenk "c" und Kragarm

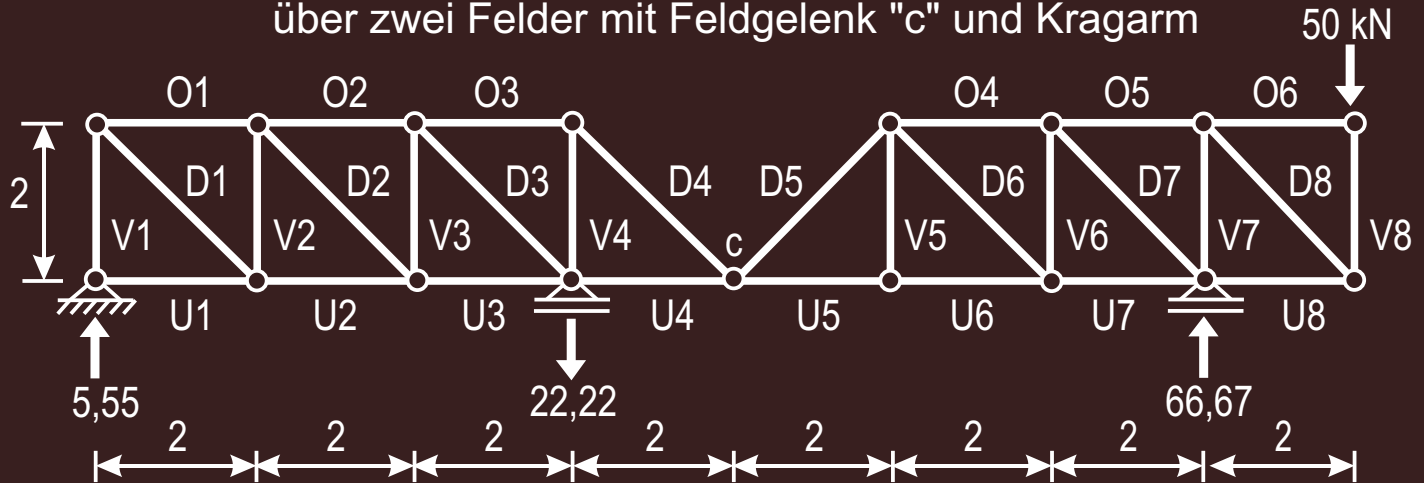

Stab	1	2	3	4	5	6	7	8
O	- 5,55	- 11,1	- 16,7	33,3	50	0		
U	0	5,55	11,1	16,7	- 16,7	- 16,7	33,3	- 50
V	- 5,55	- 5,55	- 5,55	16,7	0	16,7	- 50	- 50
D	7,86	7,86	7,86	- 23,6	23,6	- 23,6	- 23,6	70,7