

**Diethard Thieme**  
**Skripte zur Baumechanik**

**Übungen**  
**mit**  
**Lösungen**  
**BM 38**

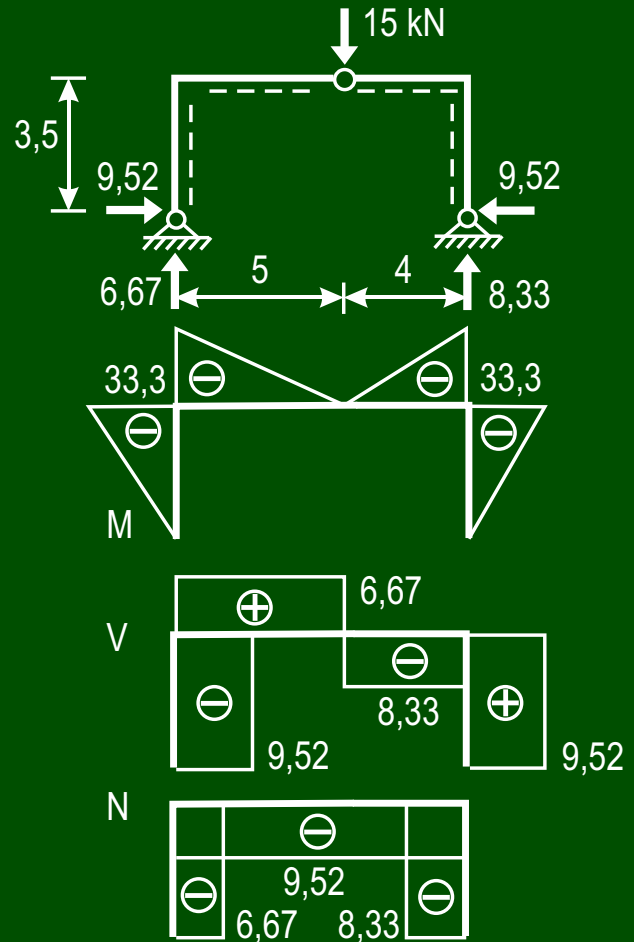

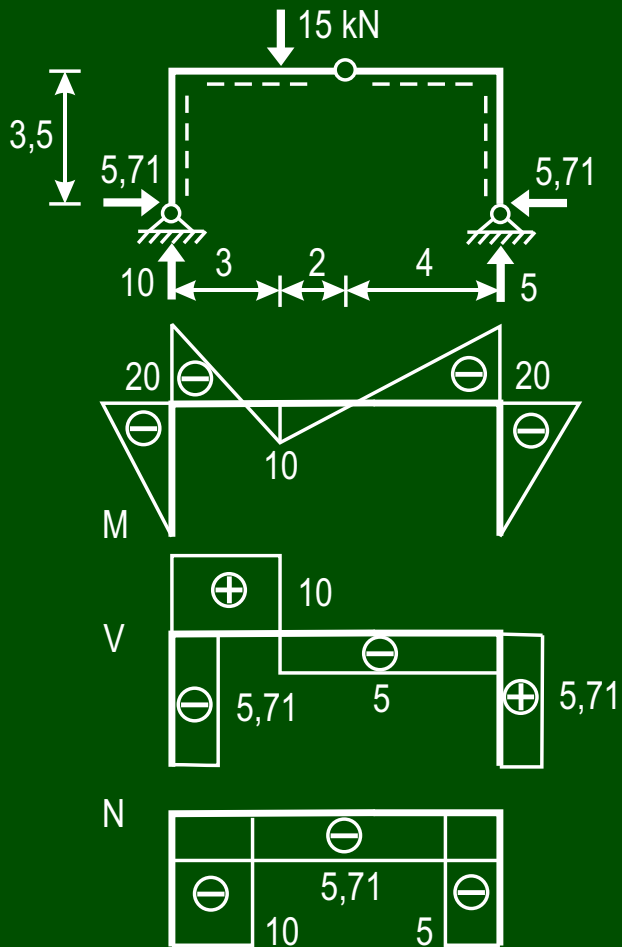

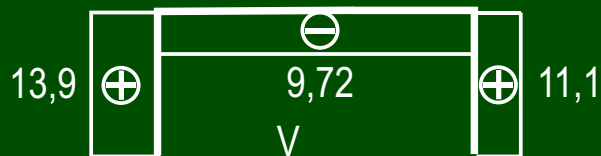
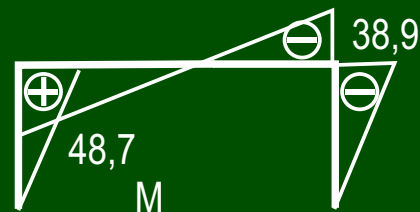
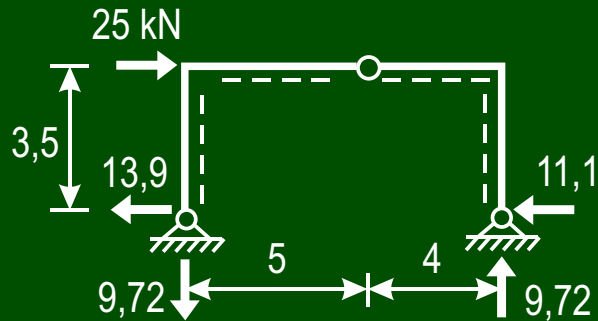
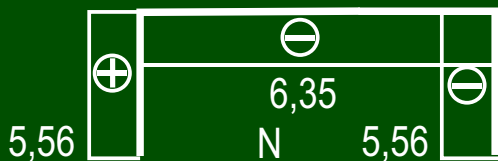
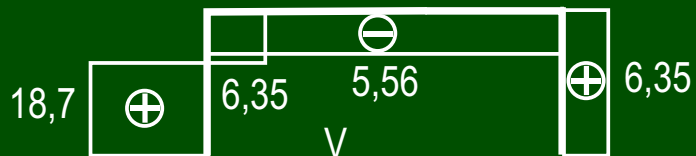
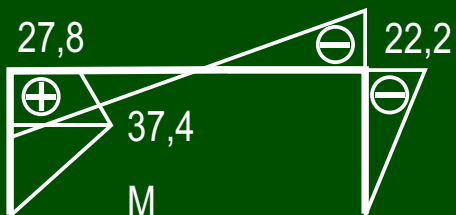
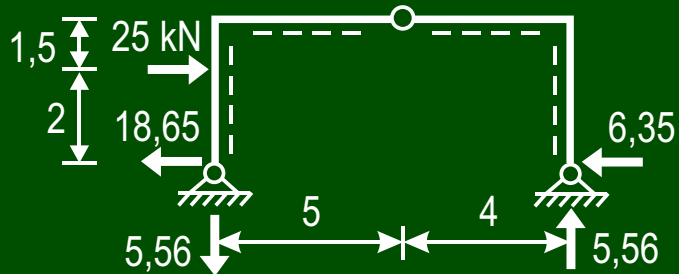
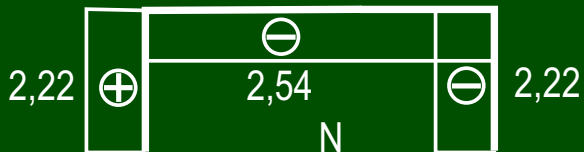
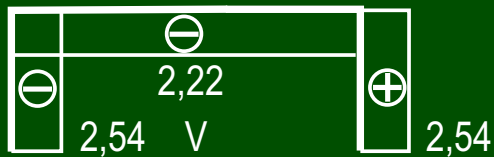
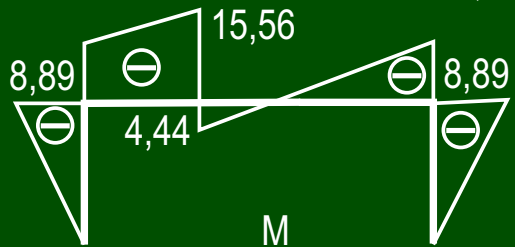
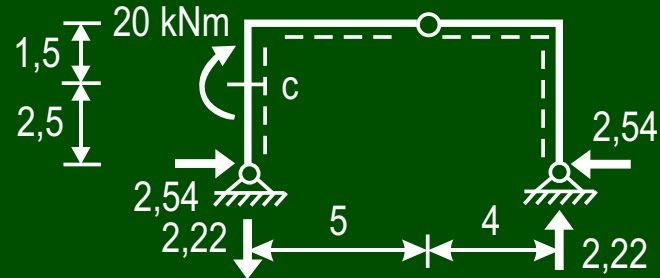
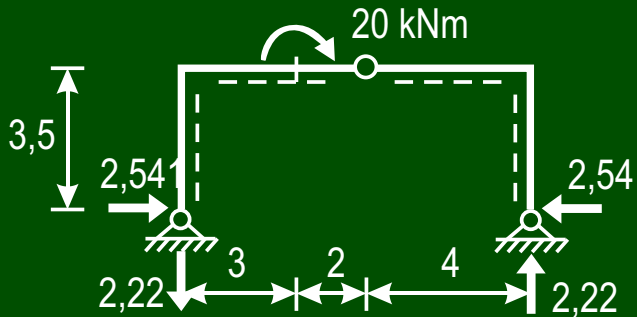

Im Punkt c  
M = 0 ?

